

Contact Address:

This information in this catalogue is subject to change without notice. The information and diagram in this catalogue reflect the technical feature and configuration of the elevator model at press time (refer to the version number). In line with the principle of continuous development of products, our company reserves the right to change the selection of product technical parameters and colour at any time. The existing image technology cannot accurately reproduce the elevator component structure and decoration colour. Therefore, this catalogue only provides general information, not as a contract document. The specific configuration parameters are subject to the formal agreement.

# Machine Room Elevator Model HCA & UCA



## Hitachi HCA & UCA Passenger Elevator

With the emergence of new scenarios and applications driven by a new technological revolution of high-speed elevator, the industrial design community is embracing new ways of thinking and creating. Given these trends, Hitachi Elevator is seeking to apply a diverse lineup of technologies to industrial design, combining the intelligent system with comfort details, with the aim of satisfying the customers need.

### CONTENTS

- 01 Energy Efficiency
- 03 Safety and Comfort
- 05 Intelligence
- 07 Car Design



# Energy Efficiency

Hitachi HCA & UCA passenger elevator achieved the highest rating of Class A for VDI4707 energy efficiency certification.

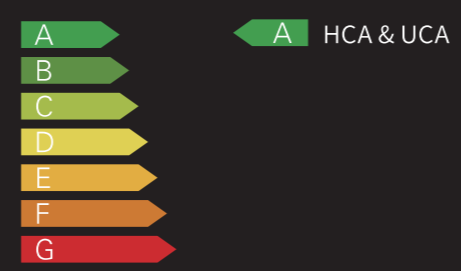

## Energy Regenerative Function

Making use of the energy generated by an elevator when traveling downwards with a heavy car load or upwards with a light car load, the traction machine acts as a power generator to transmit power back to the electrical network in the building.



## Double Permanent Magnet Configuration

Main machine using high-precision permanent magnet synchronous motors, motor pole number increases, making the control more precise. Door system using permanent magnet synchronous technology, without mechanical reduction gear, avoids the energy loss of the corresponding structures while improving the transmission efficiency.

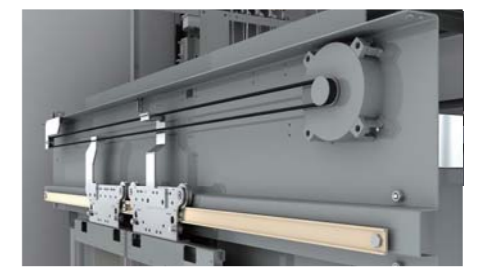

## EMC Standards\* [Option]

Hitachi HCA & UCA passenger elevators adopt EMC standards in line with the latest elevator EMC recommendation, helping that the elevator system does not cause radiation or conduction disturbance on the surrounding environment and equipment, while at the same time not under the influence of surrounding equipment.



\* Details please contact us.



# Safety & Comfort

Passenger safety and comfort is always the utmost concern, Hitachi HCA & UCA passenger elevator, equip with multiple features to ensure safe and comfortable ride.

## Multi-Beam Protection

1. Automatic Shielding  
If a single point of the multi-beam is obstructed or damaged, the system will shield the bad point, record the fault and then close the door normally on the premise of safety.
2. Auto Detection  
It can judge the specific location of the multi-beam malfunction and provide reference for quick rectification.
3. Auto Energy-Saving  
When the elevator is unoccupied, the multi-beam will be powered off so as to reduce the energy consumption and extend the lifespan of multi-beam.



## Noise Reduction

### 1 Impact of Noise

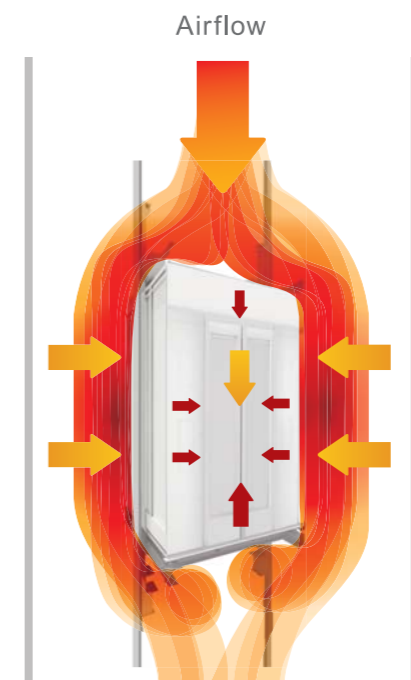
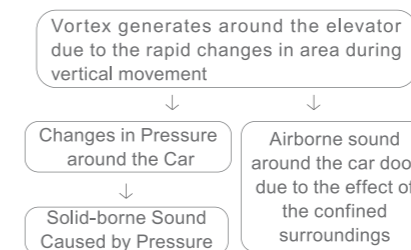

- Solid-borne Sound
- Airborne Sound
- Airflow

### 2 Hitachi Elevator uses aerodynamics simulation software, integrating practical effect verification in the development of a comfortable overall structure.



\*The above diagram is just for reference. Details, please contact us.



# Intelligence

## Precise management and control

As an indispensable transportation system for high rise buildings, Hitachi HCA and UCA passenger elevators are designed to provide intelligent solutions as high-speed elevators, making passenger transportation smarter and more convenient.

## Intelligent Allocation

The intelligent group control management system generates reasonable calls in real time according to variation of passenger traffic, thus effectively shortening the waiting and riding time.



## Reliable Control

Unique communication technology allows the elevator to achieve centralized management and decentralized control in any situation, thereby making the system more secure and reliable.



## Efficient Operation

Obtain the most efficient operating solutions through intelligent computation, dispatching the passengers to the destination floor in the shortest time



## Destination Floor Reservation System (DFRS)\* [Option]

Destination floor reservation system allows the passengers to register their destination floors on the registration devices at the main landing hall and get informed of the allocated lift serving them, this helps to reduce the congestion at the main landing hall during peak times. In addition, it improves the handling capacity and energy consumption through the unique car allocation operations.



# Car Design

- Ceiling height: 2450mm
- Rated load: 825-2000kg
- Car ceiling: RF-068
  - LED panel light + Painted steel\_WP71 (White) with ventilation outlets + LED downlight
- Car front return panel: Stainless steel hairline
- Car transom: Stainless steel hairline
- Side wall (Front panel): Stainless steel hairline
- Side wall (Middle & rear panel): Painted steel\_YM47 (Matte champagne)
- Rear wall: Painted steel\_YM47 (Matte champagne)
- Car door: Stainless steel hairline
- Car floor: FL-P124 (Vinyl tile)
- Operating panel: GOP-676

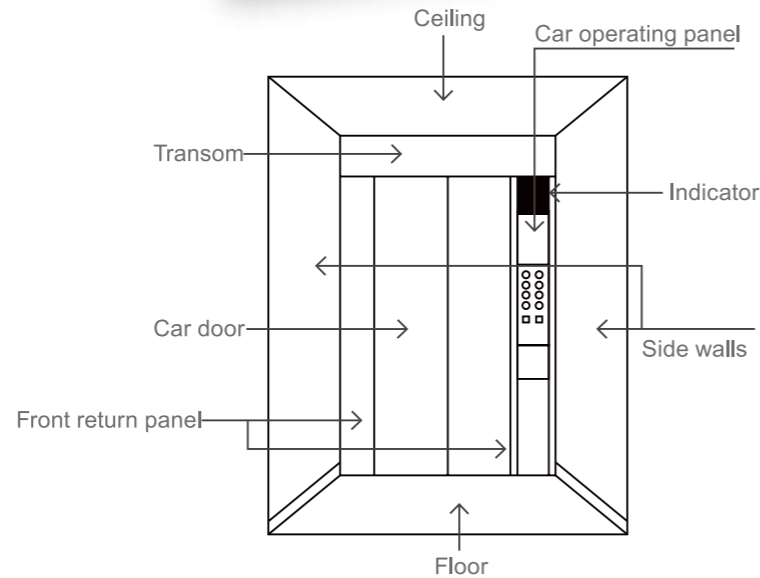

Note: Only HCA has wide car and deep car option.

# Car Design

- Ceiling height: 2450mm
- Rated load: 825-2000kg
- Car ceiling: RF-056
  - Painted-steel\_WN01 (Ivory White) with ventilation outlets + LED fluorescent tube
  - [\*Provided as standard when ceiling is by Others]
- Car front return panel: Stainless steel hairline
- Car transom: Stainless steel hairline
- Side and Rear Wall: Painted steel\_WN01 (Ivory White)
- Car door: Stainless steel hairline
- Car floor: Floor recess 20mm, finishes by Others
- Operating panel: GOP-676



Note: This design is for customers to add on decoration by themselves.

Car Operating Panel  
(With faceplate: Stainless steel hairline)

Standard

Option



GOP-676 Indicator: Monochrome LCD Button: ML-MW (Hinge type)  
 GOP-199 Indicator: Monochrome LCD Button: ML-MW (For side wall)  
 OPM-320 Indicator: Monochrome LCD Button: WL-MW  
 GOP-673 Indicator: Monochrome LCD Button: WL-MW  
 GOP-680 Indicator: Monochrome LCD Button: FL-PW  
 GOP-677 Indicator: Colour LCD Button: FL-PW (Hinge type)  
 GOP-678 Indicator: Colour LCD Button: WL-MWB (Hinge type)  
 GOP-198 Indicator: Monochrome LCD Button: WL-MWB (For side wall)

Option Horizontal Car Operating Panel  
(With faceplate: Stainless steel hairline)



GOP-610 Button: FL-PW  
 GOPC-520 Button: FL-PW

Option Colour LCD Position Indicator (In Car)



Colour LCD & Car Front Return Panel (●: Applicable)

Colour LCD Model	Display Size, W × H	Pixel	Visible Width of Car Front Return Panel (mm)			
			350	400	450	500
HCL-104C	214×161	800×600	●	●	●	●
HCL-120C	247×186	800×600	●	●	●	●
HCL-150C	304×228	1024×768	-	-	●	●

Button

Standard

Option



Note: Braille buttons are of maximum 2 digits and available as options.

Hall Operating Panel  
(With faceplate: Stainless steel hairline)



**Option** Hall Lantern  
(With faceplate: Stainless steel hairline)

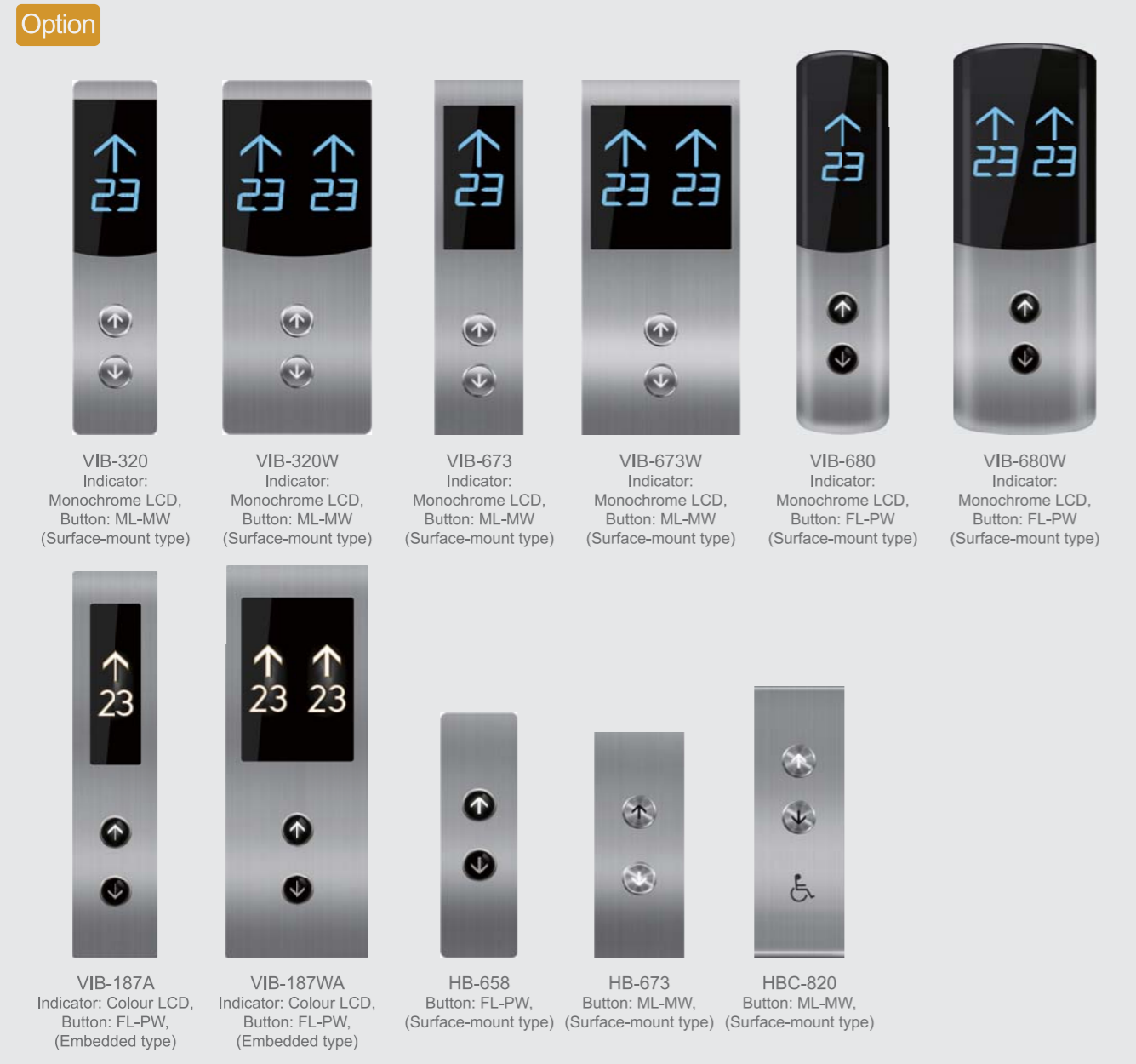
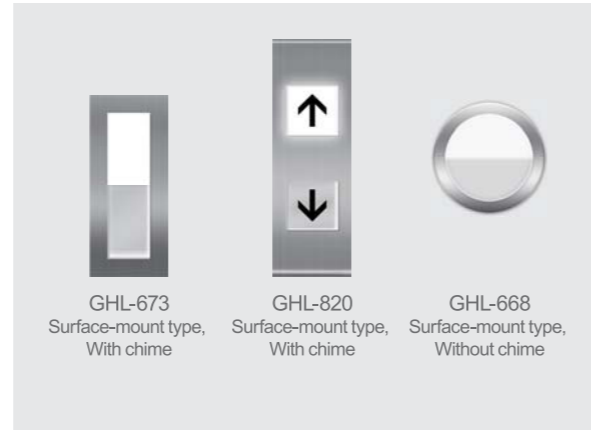

**Standard** Car Floor (Vinyl Tile)



**Option** Etching Pattern

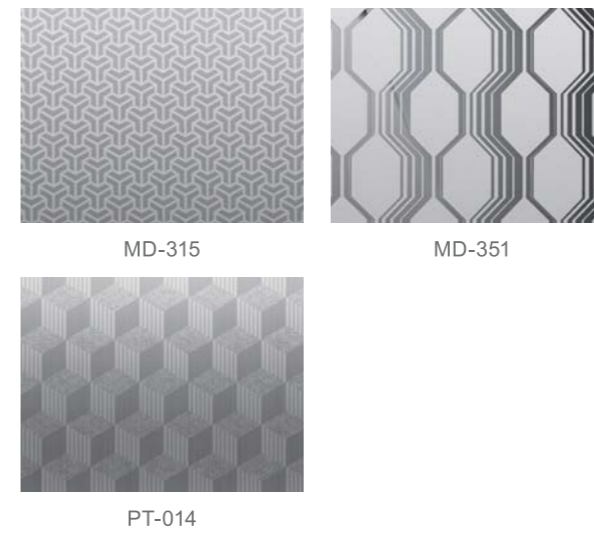

**Option** Colour Stainless Steel Hairline



**Option** Decorated Steel



**Option** Handrail





### Ceiling (Without Car Top Emergency Exit)



**RF-068 (Standard)** ① ②  
Painted Steel\_WP71 (White)



**RF-018** ① ②  
Stainless Steel Hairline +  
Painted Steel\_HP65 (Matte Black)



**RF-080** ① ②  
Painted Steel\_HP57 (Matte Light Brown)



**CE-011** ① ②  
Painted Steel\_YM47 (Matte Champagne)



**CE-027** ②  
Acrylic Panel + Aluminum Frame



**DX-301G** ②  
Acrylic Panel + Aluminum Frame



**DP-047** ②  
Stainless Steel Hairline +  
Painted Steel\_HP57 (Matte Light Brown)



**RF-013** ① ②  
Painted Steel\_BN18 (Grey)



**RF-081** ① ②  
Painted Steel\_HP57 (Matte Light Brown)



**RF-082** ① ②  
Painted Steel\_WN01 (Ivory White)



**CE-015** ① ②  
Painted Steel\_HM03 (Matte Silver)



**DP-016** ②  
Painted Steel\_YM47 (Matte Champagne)



**DP-017**  
Painted Steel\_YM47 (Matte Champagne)



**RF-056** ① ②  
Painted Steel\_BN18 (Grey)  
(Select when false ceiling is by Client)

Note:  
① Ceiling is with deep car option. (For HCA only.)  
② Ceiling is with wide car option. (For HCA only.)  
③ The ceilings illustrated above are based on 1600×1500mm car size.  
④ The ceiling profile may varies with different car size.  
⑤ Details, please contact us.

### Ceiling (With Car Top Emergency Exit)



**RF-013A**  
Painted Steel\_WN01 (Ivory White)



**RF-081A**  
Painted Steel\_HP57 (Matte Light Brown)



**RF-082A**  
Painted Steel\_WN01 (Ivory White)



**CE-015A**  
Painted Steel\_WN01 (Ivory White)



**DP-016A**  
Painted Steel\_YM47 (Matte Champagne)



**DP-017A**  
Painted Steel\_YM47 (Matte Champagne)



**RF-056A** ① ②  
Painted Steel\_WN01 (Ivory White)  
(Select when false ceiling is by Client)

Note:  
① Ceiling is with deep car option. (For HCA only.)  
② Ceiling is with wide car option. (For HCA only.)  
③ The ceilings illustrated above are based on 1600×1500mm car size.  
④ The ceiling profile may varies with different car size.  
⑤ Details, please contact us.

Standard



Jamb frame:AS-1X narrow type  
Stainless steel hairline  
Door panel:Stainless steel hairline  
Door sill:Extruded hard aluminum

Option



Jamb frame:SS-1X wide type  
Stainless steel hairline  
Door panel:Stainless steel hairline  
Door sill:Extruded hard aluminum



Jamb frame:TS-1X wide type  
Stainless steel hairline  
Door panel:Stainless steel hairline  
Door sill:Extruded hard aluminum

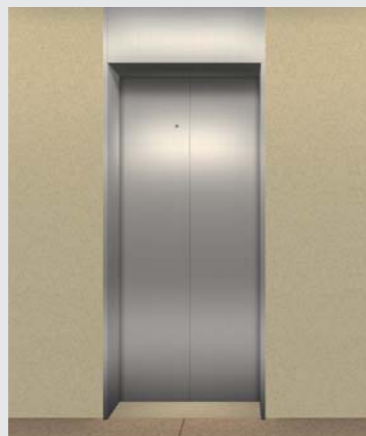

Jamb frame:SL-2X wide type with transom  
Stainless steel hairline  
Door panel:Stainless steel hairline  
Door sill:Extruded hard aluminum



Jamb frame:TL-2X wide type with transom  
Stainless steel hairline  
Door panel:Stainless steel hairline  
Door sill:Extruded hard aluminum

Car Decoration

Item	Specification	● Standard	○ Option
Ceiling Type	Without car top emergency exit: RF-068	●	
	Without car top emergency exit: RF-018/RF-080/CE-011/CE-027/DX-301G/DP-047/RF-013/RF-081/RF-082/CE-015/DP-016/DP-017/RF-056		○
	With car top emergency exit: RF-013A/RF-081A//RF-082A/CE-015A/DP-016A/DP-017A/RF-056A		○
Car Door/Transom/ Front Return Wall	Stainless steel hairline	●	
	Stainless steel mirror		○
	Stainless steel hairline / mirror etching		○
	Colour stainless steel hairline		○
	Decorated steel		○
3 Side Walls	Rust proof painted steel (RPP)		○
	Painted steel YM47 (Matte champagne)	●	
	Painted steel WN01 (Ivory White)		○
	Stainless steel hairline		○
	Stainless steel mirror		○
	Stainless steel hairline / mirror etching		○
	Colour stainless steel hairline		○
	Decorated steel		○
	Rust proof painted steel (RPP)		○
	Kickplate	Stainless steel hairline	●
Car Sill	Extruded hard aluminum	●	
	Stainless steel hairline		○
Car Floor	Vinyl tile (FL-P124 / A-26 / S-048 / S-693 / FL-P008 / S-033)	●	
	Floor recess (20mm), Finishes by Others		○
	Floor recess (25mm/30mm), Finishes by Others		○
Handrail	AA-Y138		○
	AA-BS		○
	HR-M037		○
	HR-M050		○
Car Operating Panel (At Front Return Wall)	GOP-676	●	
	OPM-320 / GOP-673 / GOP-680 / GOP-677 / GOP-678		○
Car Operating Panel(At Side Wall)	GOP-199	●	
	GOP-198 / GOP-610 / GOPC-520		○

Entrance

Item	Specification	● Standard	○ Option
Jamb Type	AS-1X, Jamb width=50mm	●	
	SS-1X, Jamb width≤300mm		○
	SL-2X, Jamb width≤300mm		○
	TS-1X, Jamb width≤300mm		○
	TL-2X, Jamb width≤300mm		○
Jamb Finish	Stainless steel hairline	●	
	Stainless steel mirror		○
	Colour stainless steel hairline		○
	Rust proof painted steel (RPP)		○
Landing Door	Stainless steel hairline	●	
	Stainless steel mirror		○
	Stainless steel hairline / mirror etching		○
	Colour stainless steel hairline		○
	Decorated steel		○
Landing Sill	Rust proof painted steel (RPP)		○
	Extruded hard aluminum	●	
Hall Operating Panel	Stainless steel hairline	●	
	VIB-676 / VIB-676W		○
	VIB-320 / VIB-320W / VIB-673 / VIB-673W / VIB-680 / VIB-680W / VIB-187A / VIB-187WA		○
Hall Lantern	HB-673 / HB-658 / HB-820		○
	GHL-668		○
	GHL-673		○
Hall Indicator	GHL-820		○
	Colour LCD Position Indicator		○

Buttons

Item	Specification	● Standard	○ Option
Buttons	ML-MW	●	
	WL-MO / WL-MW / WL-MB / WL-MWB / GL-MOA / GL-MW / GL-MB / FL-PW / XL-MO / XL-MW / XL-MB / XL-MOA / XL-MWA / XL-MBA / HL-PWA		○